

# Block diagrams

■ Main section

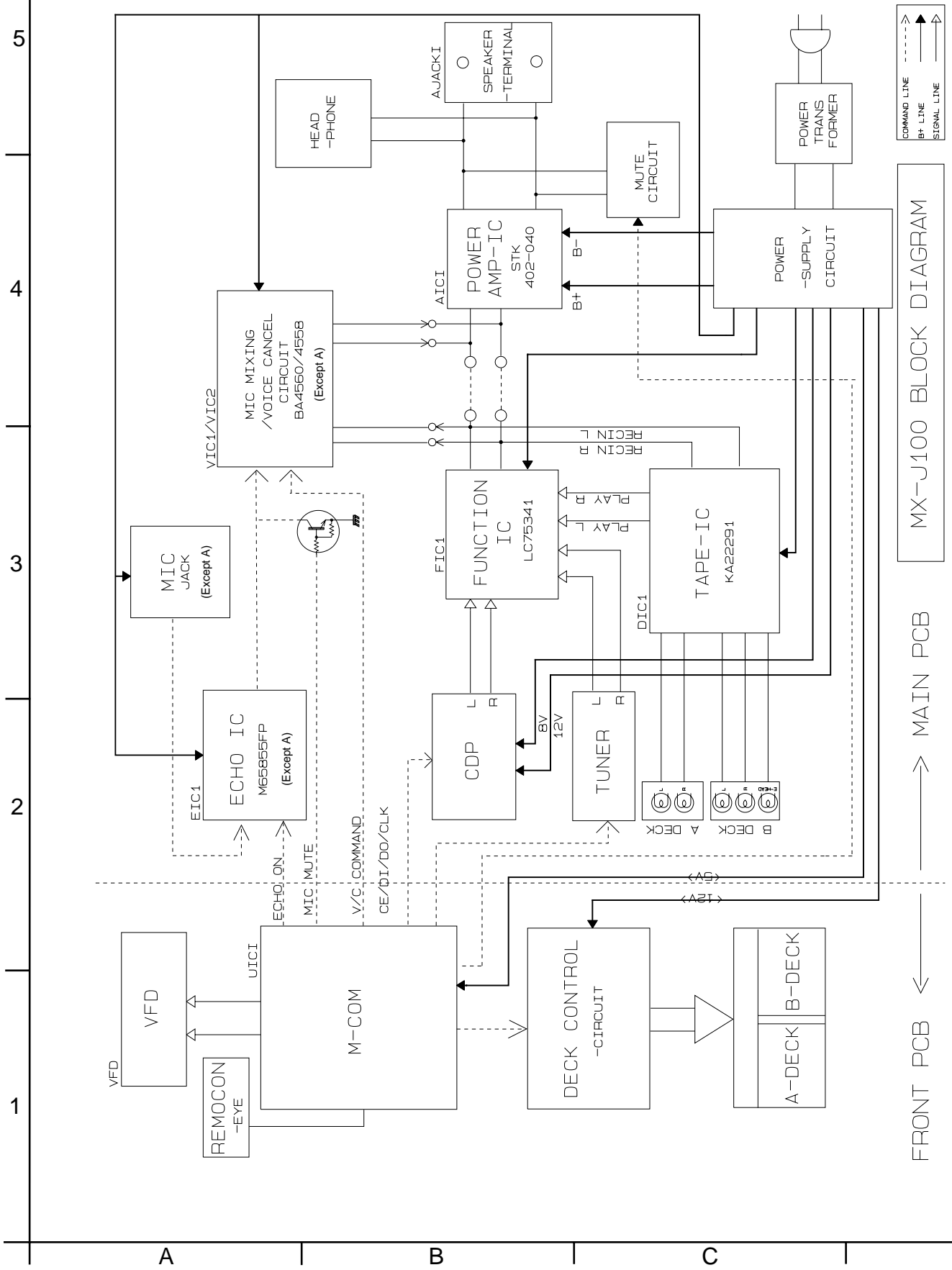

MX-J100 BLOCK DIAGRAM

MAIN PCB

FRONT PCB

5

4

3

2

1

A

B

C

■ CD section

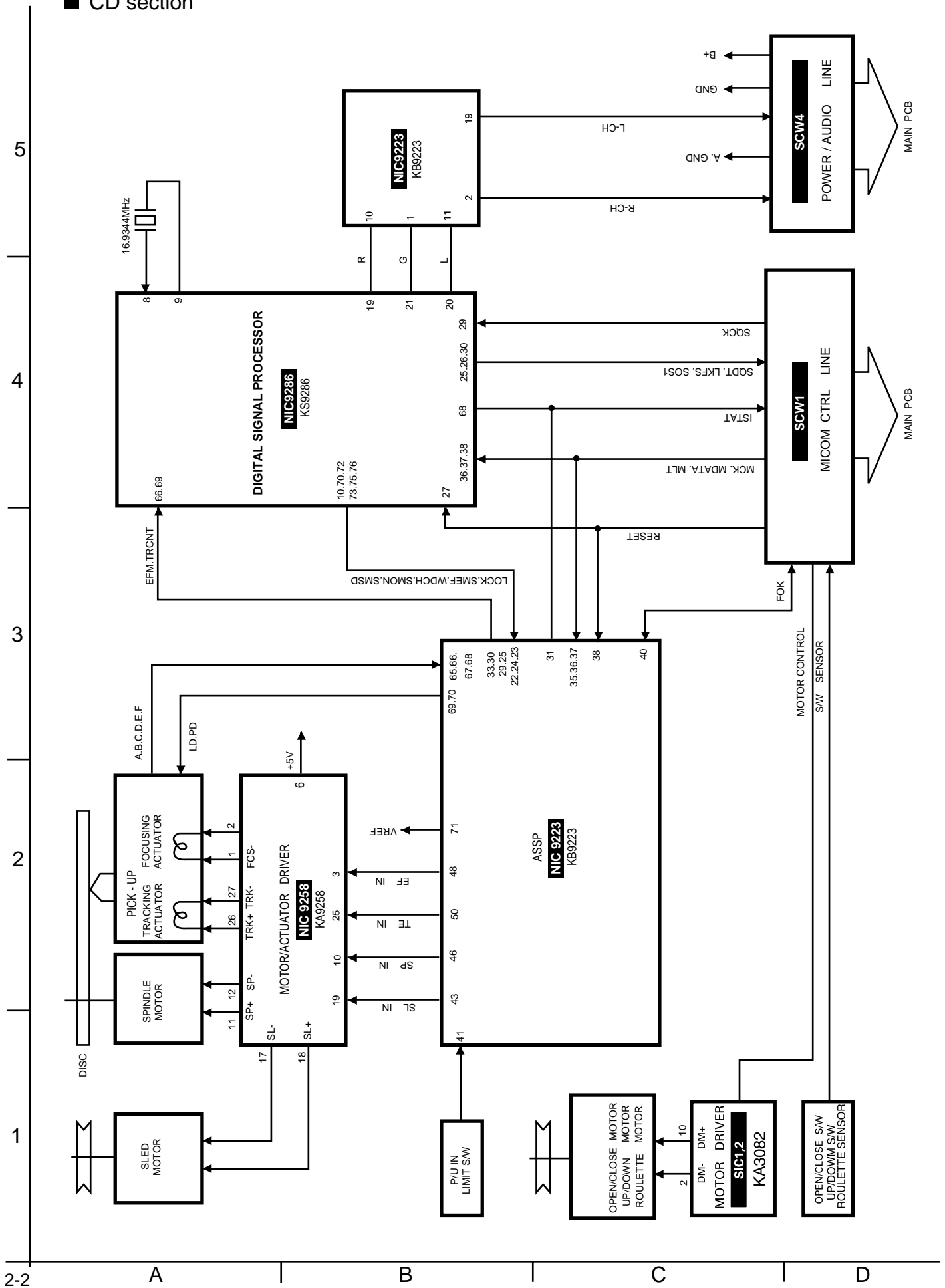

# Standard schematic diagrams

## ■ Front section

### FRONT CIRCUIT

5  
4  
3  
2  
1

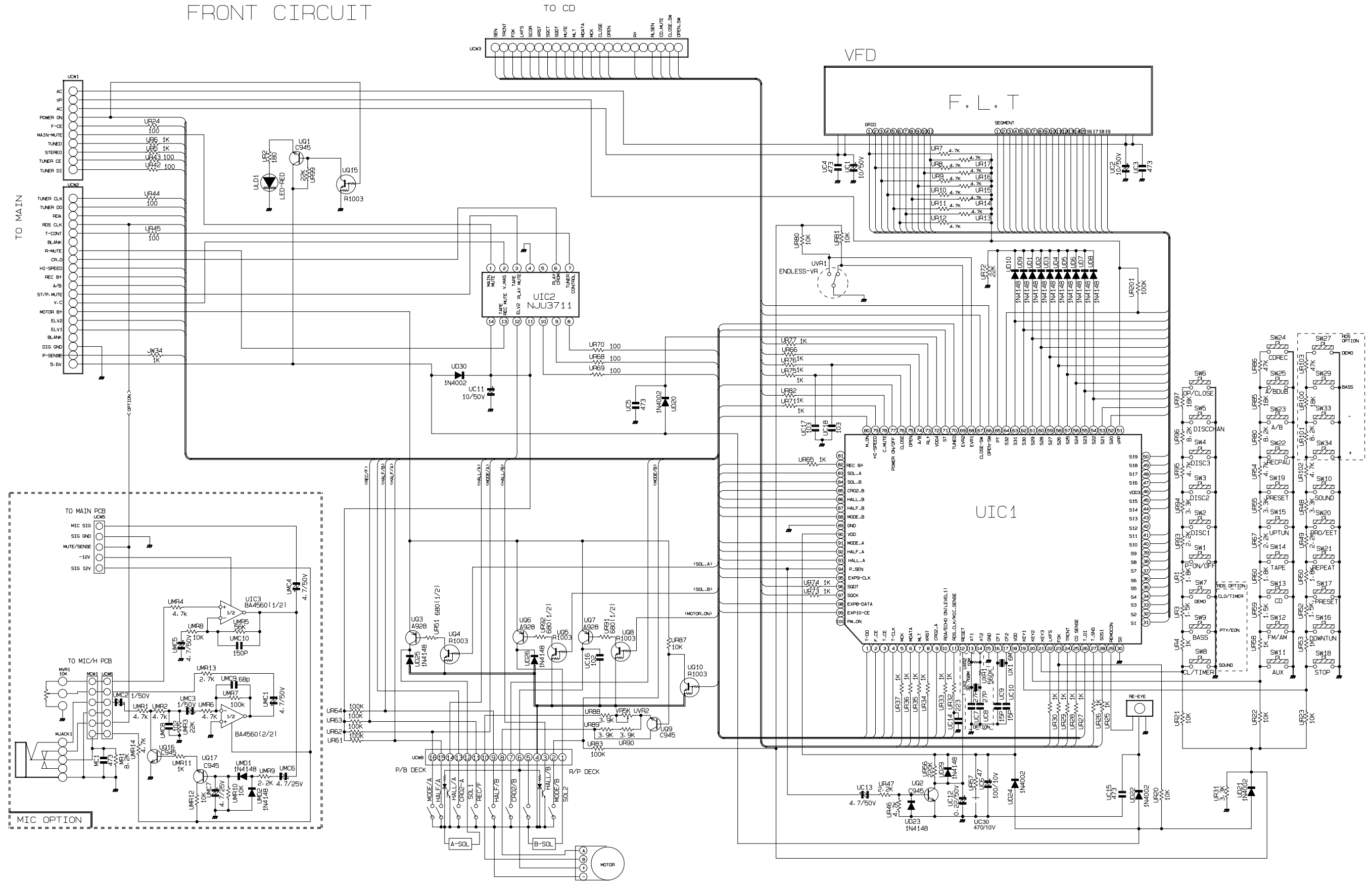

A

B

C

D

E

F

G

CD section

5

4

3

2

1

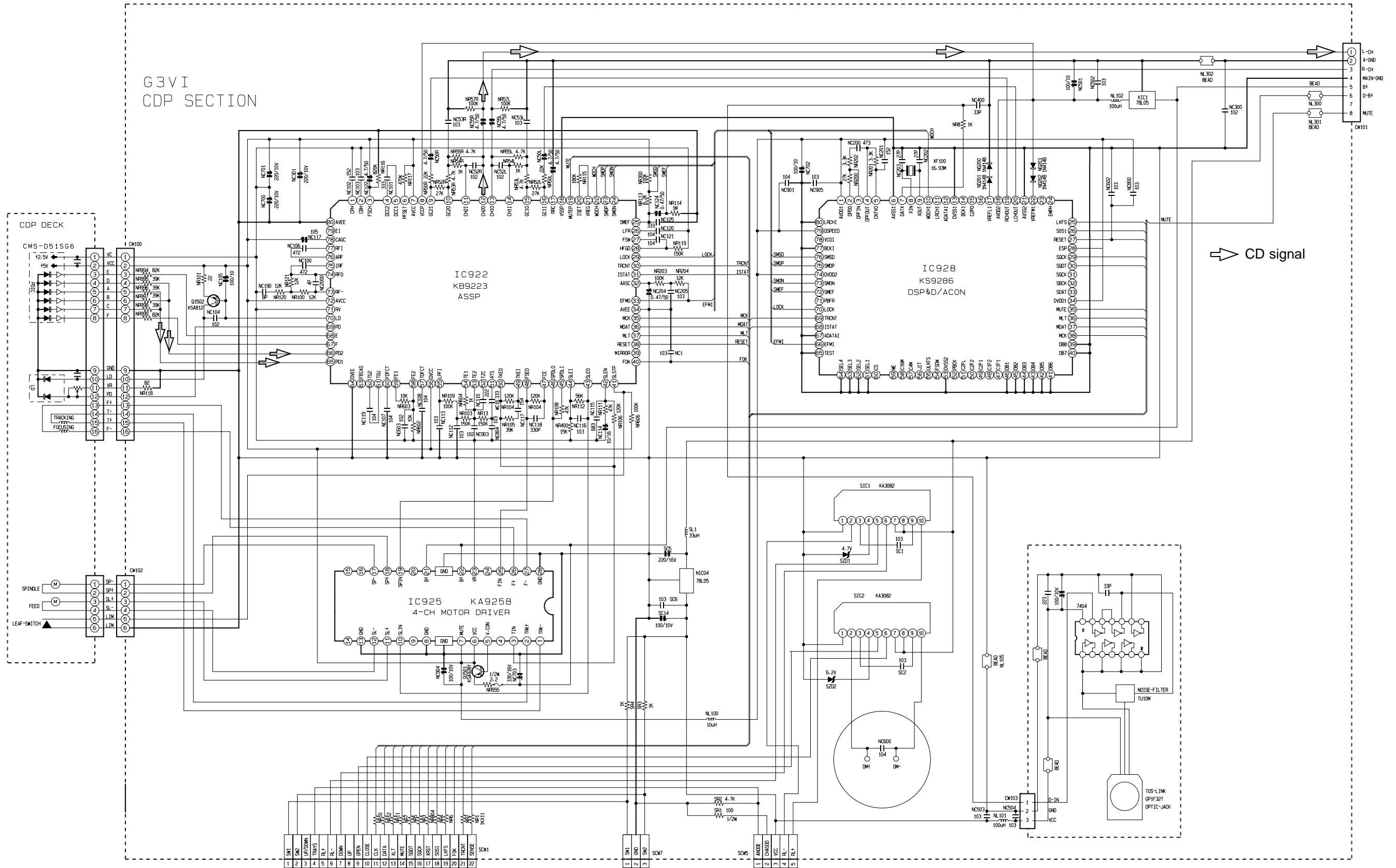

CD signal

A

B

C

2-4

D

E

F

G

H

■ Main section

5  
4  
3  
2  
1

- ➔ AUX signal
- ➔ CD signal
- ➔ Tape signal
- ➔ Main signal
- ➔ Tuner signal

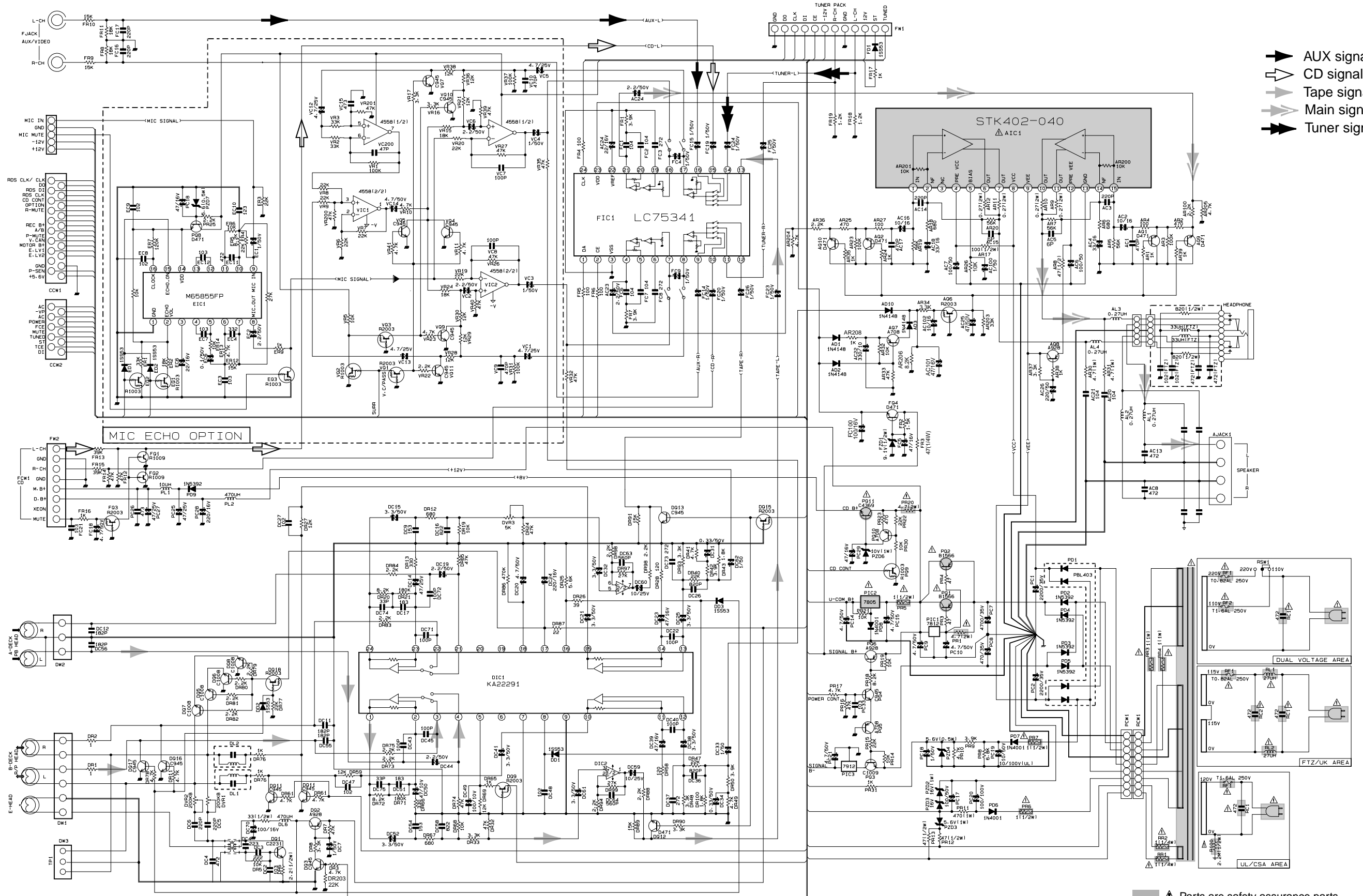

▲ Parts are safety assurance parts.  
When replacing those parts make  
sure to use the specified one.

■ Tuner section

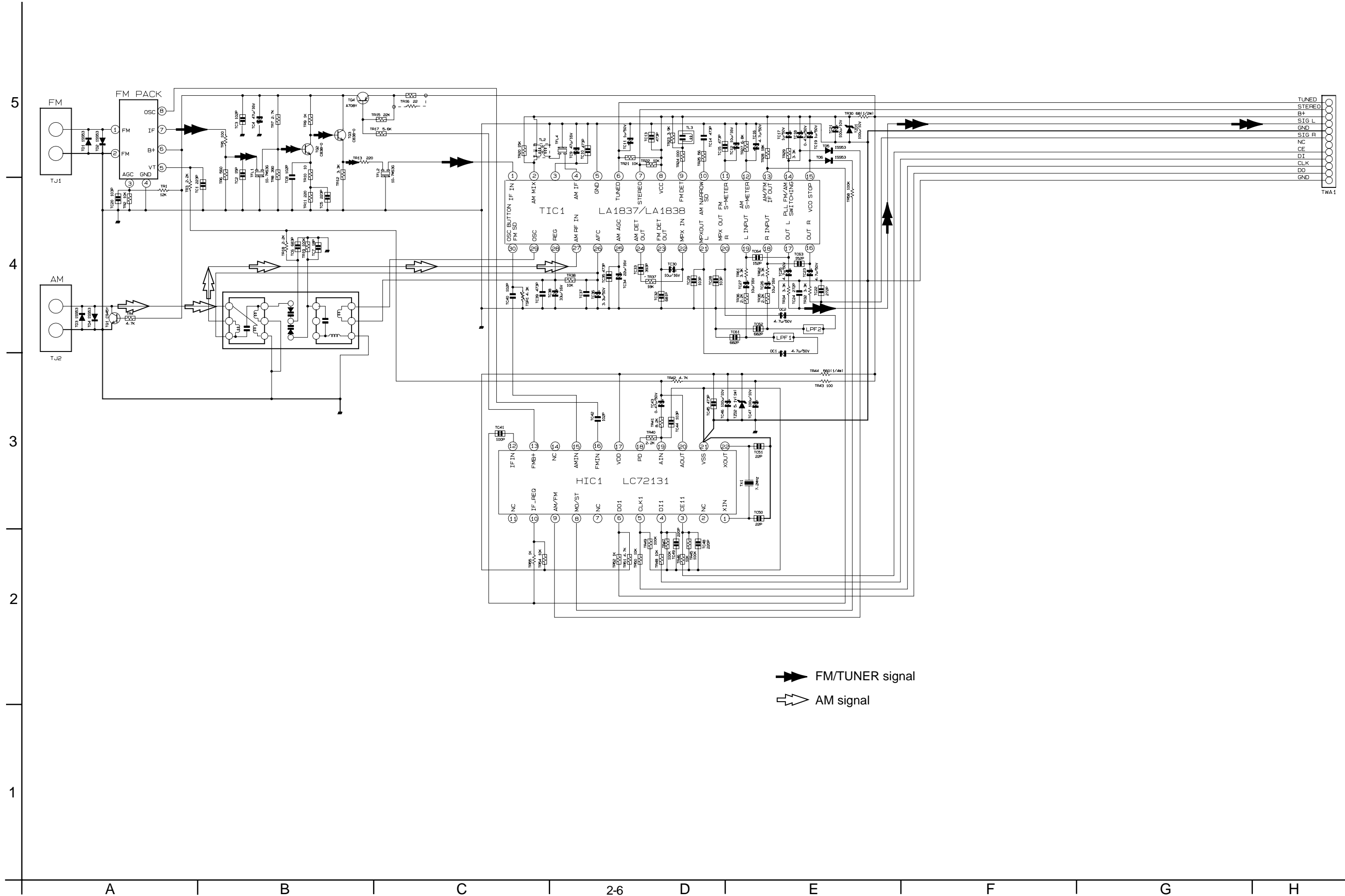

# Printed circuit boards

## ■ Main board

5  
4  
3  
2  
1

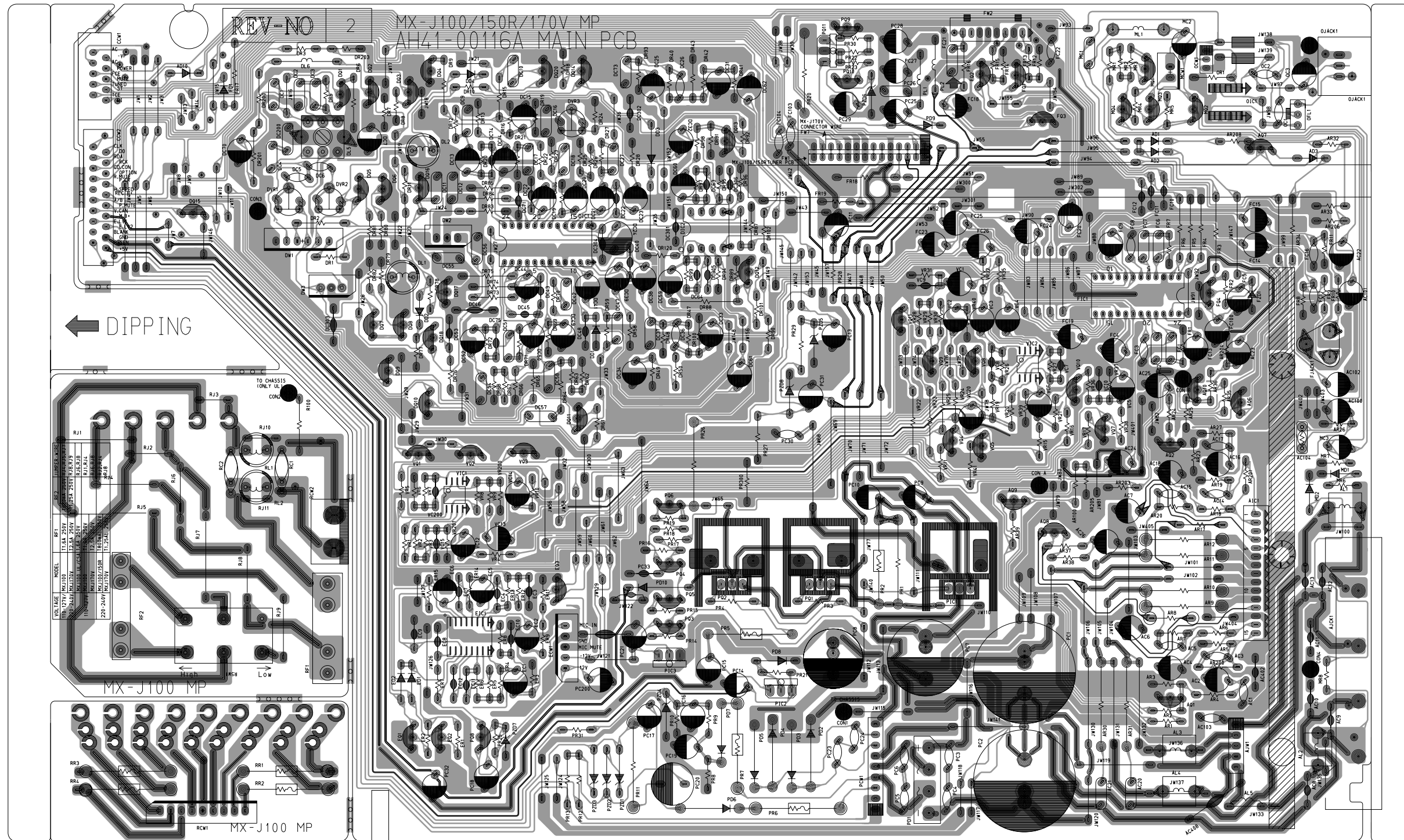

\*\*\* DIODE \*\*\*

- AD1 (J5)
- AD10 (B6)
- AD2 (J5)
- AD3 (K5)
- DD1 (E4)
- DD2 (D4)
- DD3 (F5)
- DD4 (D6)
- ED1 (D1)
- ED2 (D1)
- FD1 (B6)
- FZD1 (J4)
- MD1 (K2)
- MD2 (K2)
- PD10 (E1)
- PD2 (G0)
- PD3 (G0)
- PD4 (F0)
- PD5 (F0)
- PD6 (F0)
- PD7 (F0)
- PD8 (G1)
- PD9 (H5)
- PZD1 (E0)
- PZD2 (E0)
- PZD3 (E0)
- PZD4 (F1)
- PZD5 (G4)
- PZD6 (G6)
- PZD7 (D0)
- PZD8 (G3)

\*\*\* IC&WAFER \*\*\*

- AJW1 (J0)
- DW1 (C4)
- DW2 (D4)
- ECW1 (E1)
- FW1 (G5)
- FW2 (H6)
- FW7 (G5)
- MCW1 (J6)
- OCW1 (J6)
- PCW1 (G0)
- RCW1 (B0)

A B C D E F G

■ CD board

5

4

3

2

1

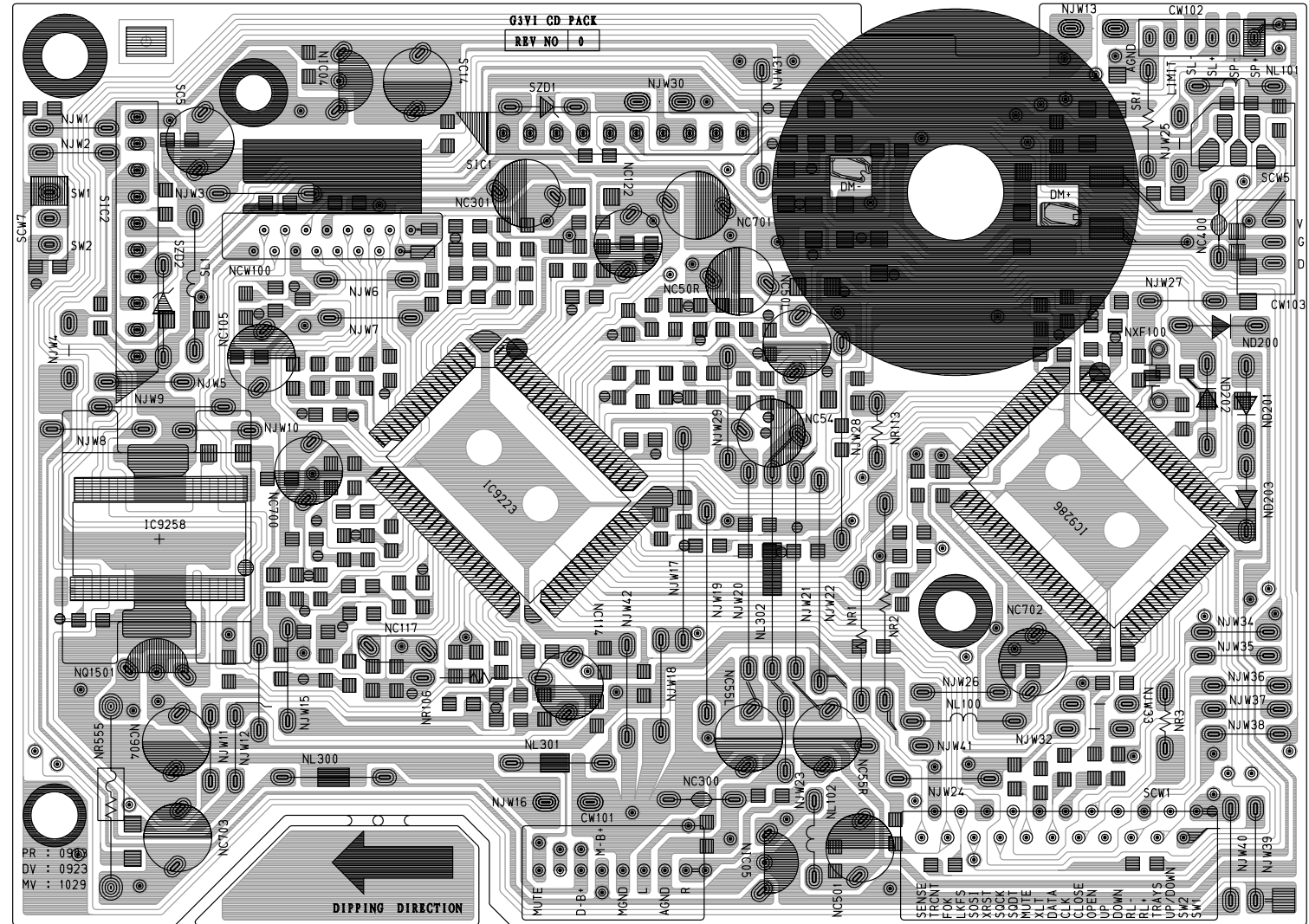

\*\*\* RESISTOR \*\*\*

- NR1 (C0)
- NR106 (B0)
- NR113 (C1)
- NR2 (C0)
- NR3 (D0)
- NR555 (A0)
- SR1 (D2)

\*\*\* DIODE \*\*\*

- ND201 (D1)
- ND202 (D1)
- ND203 (D1)
- SZD1 (B2)
- SZD2 (A1)

\*\*\* CONDENSER \*\*\*

- NC105 (A1)
- NC114 (B0)
- NC117 (B0)
- NC122 (B2)
- NC300 (C0)
- NC301 (B2)
- NC400 (D1)
- NC501 (C0)
- NC50L (C1)
- NC50R (C1)
- NC54 (C1)
- NC55L (C0)
- NC55R (C0)
- NC700 (A1)
- NC701 (C2)
- NC702 (D0)
- NC703 (A0)
- NC904 (A0)
- SC5 (A2)

\*\*\* TR \*\*\*

- NIC04 (B2)
- NIC05 (C0)
- Q1501 (A0)

\*\*\* IC&WAFER \*\*\*

- CW101 (B0)
- CW102 (D2)
- CW103 (E1)
- SCW7 (A2)
- SIC1 (B2)
- SIC2 (A1)

■ Headphone & MIC board

\*\*\* RESISTOR \*\*\*

- HR1 (A0)
- HR2 (A0)
- MR1 (A0)

\*\*\* IC&WAFER \*\*\*

- HCW1 (B0)
- MCW1 (A0)

\*\*\* CONDENSER \*\*\*

- HC1 (A0)
- HC2 (A0)
- HC3 (A0)
- HC4 (A0)
- MC1 (A0)

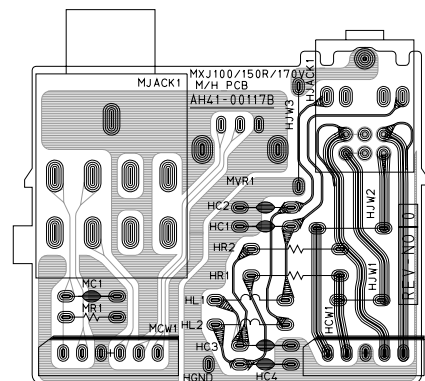



■ Front board

5

4

3

2

1

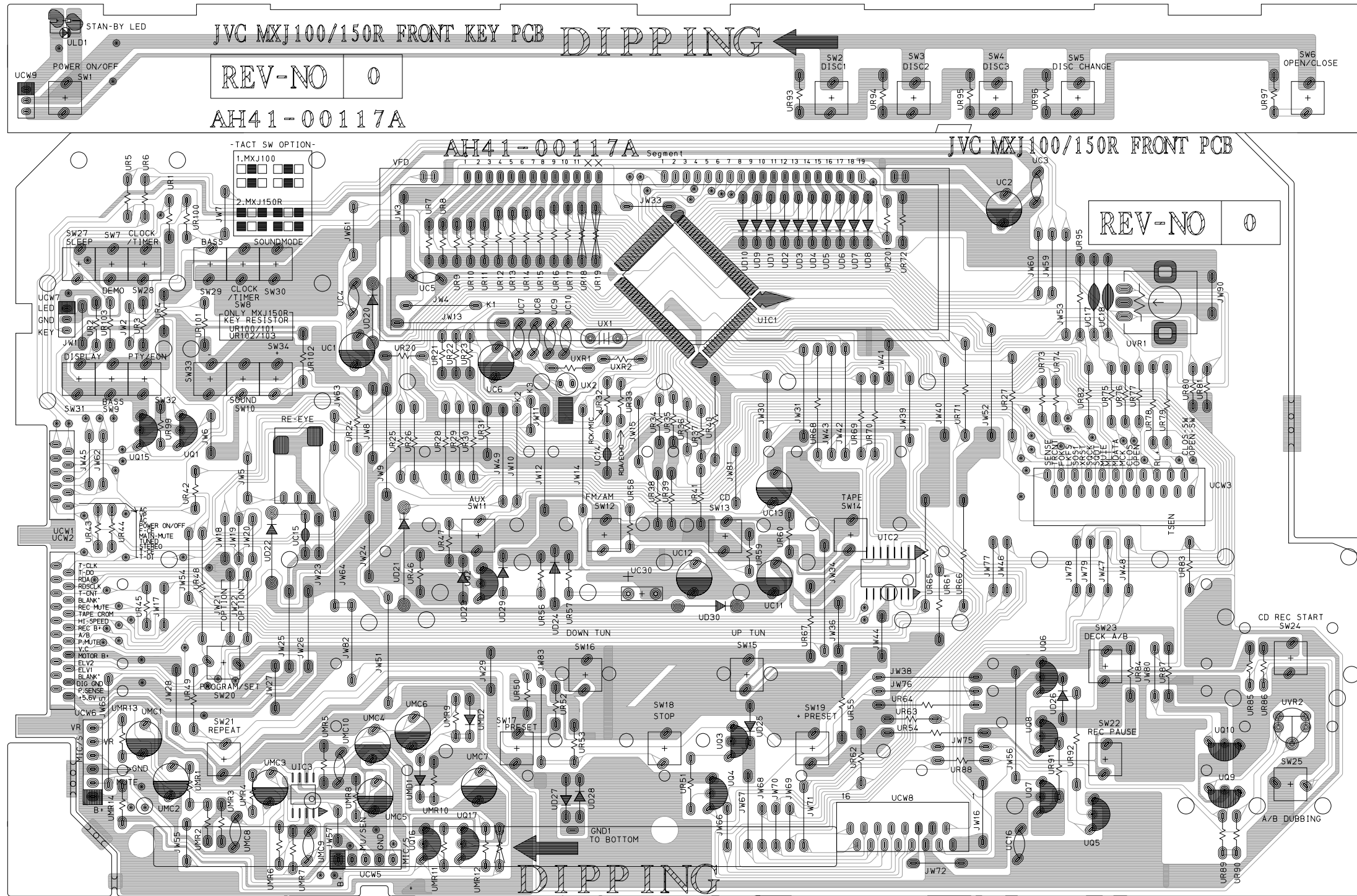

\*\*\* CONDENSER \*\*\*    \*\*\* TR \*\*\*

- UC1 (C3)
- UC10 (D3)
- UC11 (E2)
- UC12 (E2)
- UC13 (E2)
- UC14 (D2)
- UC15 (B2)
- UC16 (G0)
- UC17 (G3)
- UC18 (G3)
- UC2 (G4)
- UC3 (G4)
- UC4 (C3)
- UC5 (C3)
- UC6 (C3)
- UC7 (D3)
- UC8 (D3)
- UC9 (D3)
- UCM1 (A1)
- UCM10 (C0)
- UCM2 (A0)
- UCM3 (B0)
- UCM4 (C1)
- UCM5 (C0)
- UCM6 (C1)
- UCM7 (C0)
- UCM8 (B0)
- UCM9 (B0)
- UQ1 (B2)
- UQ10 (H0)
- UQ15 (A2)
- UQ16 (C0)
- UQ17 (C0)
- UQ2 (C1)
- UQ3 (E1)
- UQ4 (E0)
- UQ5 (G0)
- UQ6 (G1)
- UQ7 (G0)
- UQ8 (G1)
- UQ9 (H0)

\*\*\* IC&WAFER \*\*\*

- EIC2 (B0)
- SW1 (A4)
- SW10 (B3)
- SW11 (C2)
- SW12 (D2)
- SW13 (E2)
- SW14 (F2)
- SW15 (E1)
- SW16 (D1)
- SW17 (D0)
- SW18 (E0)
- SW19 (E0)
- SW2 (F4)
- SW20 (B1)
- SW21 (B0)
- SW22 (G0)
- SW23 (G1)
- SW24 (H1)
- SW25 (H0)
- SW27 (A3)
- SW28 (A3)
- SW29 (B3)
- SW3 (F4)
- SW30 (B3)
- SW31 (A3)
- SW32 (A3)
- SW33 (B3)
- SW34 (B3)
- SW4 (G4)
- SW5 (G4)
- SW6 (H4)
- SW7 (A3)
- SW8 (B3)
- SW9 (A3)
- UC30 (D1)
- UCW5 (C0)
- UCW6 (A0)
- UCW7 (A3)
- UCW9 (A4)
- UIC1 (E3)

\*\*\* DIODE \*\*\*

- UD1 (E3)
- UD10 (E3)
- UD2 (E3)
- UD20 (C3)
- UD21 (C2)
- UD22 (B2)
- UD23 (C2)
- UD24 (D2)
- UD25 (E0)
- UD26 (G1)
- UD27 (D0)
- UD28 (D0)
- UD29 (D2)
- UD3 (E3)
- UD30 (E1)
- UD4 (E3)
- UD5 (E3)
- UD6 (F3)
- UD7 (F3)
- UD8 (F3)
- UD9 (E3)
- UMD1 (C0)
- UMD2 (C0)
- SW2 (F4)
- SW20 (B1)
- SW21 (B0)
- SW22 (G0)
- SW23 (G1)
- SW24 (H1)
- SW25 (H0)
- SW27 (A3)
- SW28 (A3)
- SW29 (B3)
- SW3 (F4)
- SW30 (B3)
- SW31 (A3)
- SW32 (A3)
- SW33 (B3)
- SW34 (B3)
- SW4 (G4)
- SW5 (G4)
- SW6 (H4)
- SW7 (A3)
- SW8 (B3)
- SW9 (A3)
- UC30 (D1)
- UCW5 (C0)
- UCW6 (A0)
- UCW7 (A3)
- UCW9 (A4)
- UIC1 (E3)

■ Tuner board

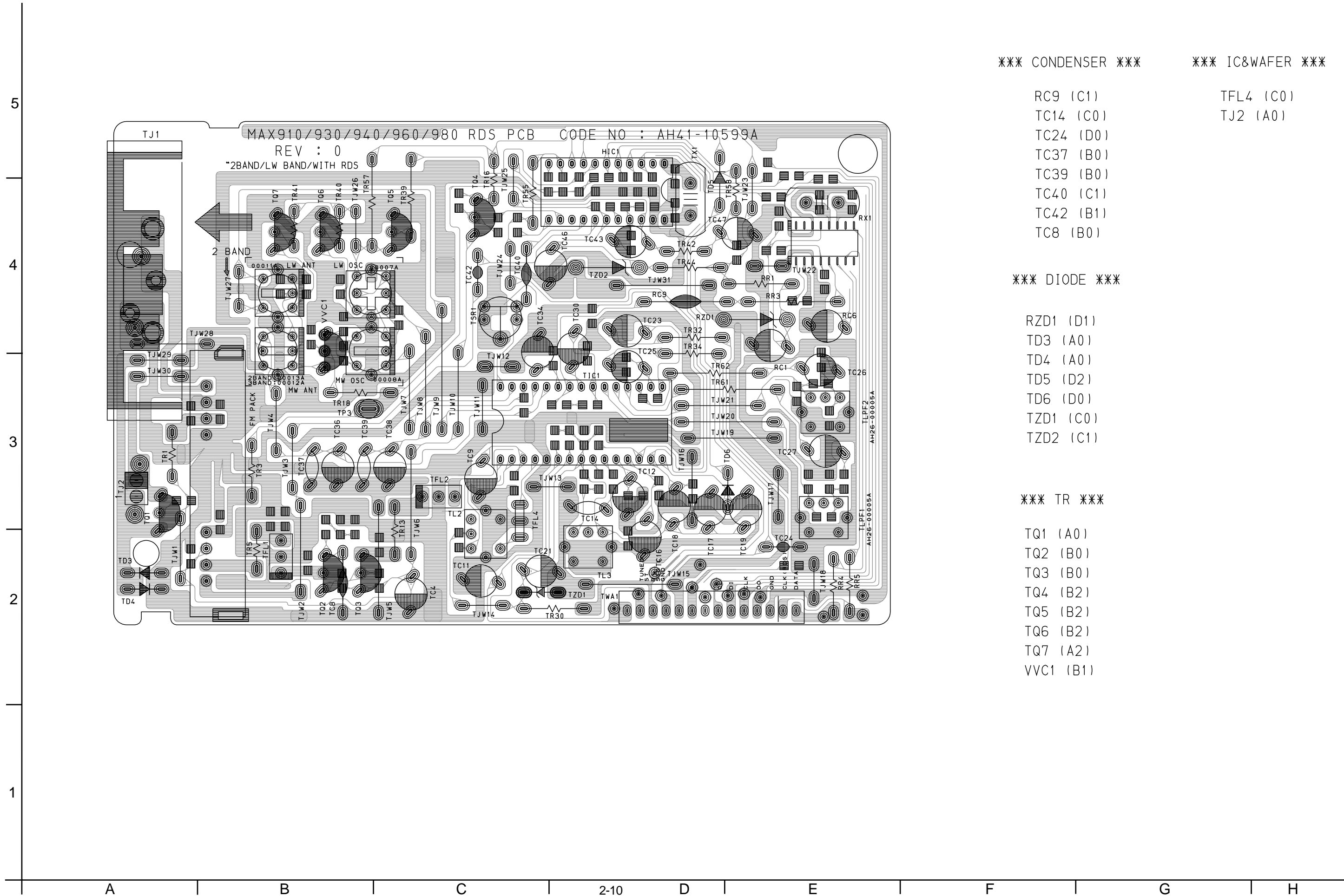

\*\*\* CONDENSER \*\*\*

\*\*\* IC&WAFER \*\*\*

- RC9 (C1)
- TC14 (C0)
- TC24 (D0)
- TC37 (B0)
- TC39 (B0)
- TC40 (C1)
- TC42 (B1)
- TC8 (B0)
- TFL4 (C0)
- TJ2 (A0)

\*\*\* DIODE \*\*\*

- RZD1 (D1)
- TD3 (A0)
- TD4 (A0)
- TD5 (D2)
- TD6 (D0)
- TZD1 (C0)
- TZD2 (C1)

\*\*\* TR \*\*\*

- TQ1 (A0)
- TQ2 (B0)
- TQ3 (B0)
- TQ4 (B2)
- TQ5 (B2)
- TQ6 (B2)
- TQ7 (A2)
- VVC1 (B1)